



AIR COOLED CONFIGURED  
**SCREW  
CHILLERS**  
HIGH-EFFICIENCY SERIES

IT HAS EVERYTHING YOU LOOK FOR IN A CHILLER.  
CUSTOMISATION. HIGH-EFFICIENCY.  
ECO-FRIENDLY. LOW NOISE.



## AIR COOLED CONFIGURED SCREW CHILLERS - HIGH-EFFICIENCY SERIES

Blue Star, India's largest central air conditioning company has been providing expert cooling solutions for over seven decades now. As a leader in the industry, it manufactures a wide range of scroll, screw and centrifugal chillers, providing cool comfort in hospitals, airports, green buildings, hotels, malls etc.

Based on its continued thrust for research and product development, Blue Star launches a new state-of-the-art configured series of AHRI certified air cooled screw chillers. These chillers provide application versatility, energy efficiency, low sound levels, precision control, reliability, ease of installation and operational cost effectiveness. The chillers are designed to deliver high performance and a host of other benefits.



## MADE IN INDIA - MADE FOR INDIA

The new configured series screw chiller is manufactured at Blue Star's ISO 9001 certified factory. Blue Star has state-of-the-art chiller testing facility certified by the Air Conditioning, Heating and Refrigeration Institute (AHRI). The chillers are designed to deliver better efficiencies even at high ambient temperature prevalent in India.



## WIDE CAPACITY RANGE

The chillers are offered in a wide range of capacities from 100TR to 400TR with single/twin compressors. The performance is validated by AHRI. The condenser surface area and number of passes across the cooler can be modified to suit project capacity, pressure drop and efficiency. The chillers are designed to operate at 415V, 50Hz, on a 3-phase power supply.



Single Compressor Range:



**100TR to 200TR**

Double Compressor Range:



**130TR to 400TR**

## PROJECT SPECIFIC CHILLER DESIGN

The new Blue Star configured high-efficiency series aircooled screw chiller can be selected based on project specific requirement. Unlike the conventional chillers, Blue Star's latest screw chillers are not limited to a few models. The configured series has an exhaustive range of coolers, condensers and compressors which offers flexibility to select chillers based on varied needs of customers like:

- Capacity
- Energy efficiency
- Ambient temperature
- Pressure drops
- Noise levels
- Flow rates
- Dimensions



**Cooler**

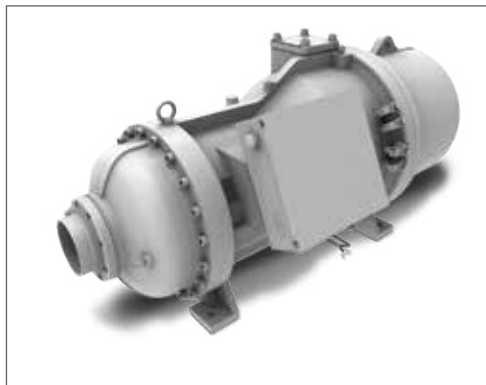

**Compressor**



**Condenser**





## HIGH ENERGY EFFICIENCY

The new Blue Star configured series screw chiller is designed for high performance, both at full load and part load. This series comes with:

- High-efficiency semi-hermetic twin screw compressors.

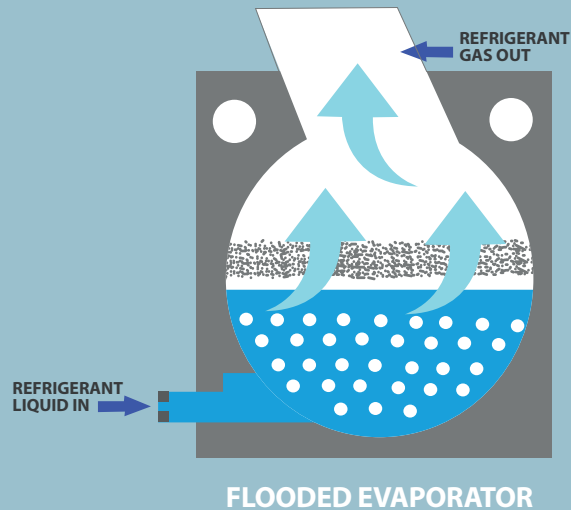

- Flooded evaporator design that aids in:
  - ◆ Reducing the temperature gradient between the refrigerant and water
  - ◆ Higher evaporating temperature
  - ◆ Negligible superheat
  - ◆ All the above resulting in higher efficiency
  - ◆ Electronic expansion device to precisely control the refrigerant flow
- VFD drive option for condenser fan motor, providing varied benefits like:
  - ◆ Compatibility with low ambient temperature (up to 0°C) applications
  - ◆ Optimised noise levels



The new high-efficiency series offers exceptional COP and IPLV values exceeding the national and international energy norms like ECBC and ASHRAE 90.1.

### ECBC Values

Chiller Type	Capacity	Minimum Efficiency	
		COP	IPLV
Air Cooled Screw	< 150TR	2.9	3.16
Air Cooled Screw	> 150TR	3.05	3.32

### ASHRAE 90.1

### Minimum Efficiency

Capacity Range	Path A (kW/TR)		Path B (kW/TR)	
	COP	IPLV	COP	IPLV
< 150TR	2.96	4.02	2.84	4.63
> 150TR	2.96	4.1	2.84	4.72

## CHILLERS DESIGNED FOR GREEN BUILDING

Green buildings are environmentally sustainable and are designed, constructed and operated to minimise any adverse impact on the environment.

An air conditioning system consumes about 40% of the annual building energy. Therefore, selection of the right air conditioning system is one of the main aspects to consider while designing a green building.

The choice of Heating, Ventilation and Air Conditioning (HVAC) products can have a significant impact on LEED certification as it can influence 40% of the available points.

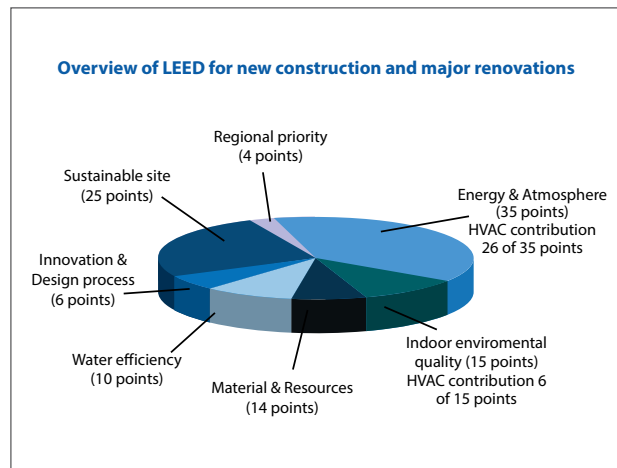
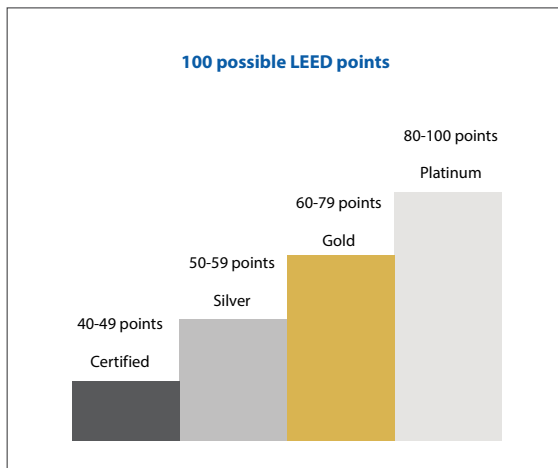

### EA prerequisite 2 : Minimum Energy Performance

The chillers shall meet the energy efficiency requirements of ASHRAE 90.1.

### EA prerequisite 3 : Fundamental Refrigerant Management

The chillers shall not use Chlorofluorocarbon (CFC) refrigerants.

### EA credit 4 : Enhanced Refrigerant Management

LEED awards the systems that minimise the Ozone Depletion Potential (ODP) and Global Warming Potential (GWP).

### EA credit 1 : Optimised Energy Performance

One section of this credit requires the reduction in energy consumption exceeding the ASHRAE 90.1 minimum efficiency beyond EA prerequisite 2.

**The high-efficiency series of chillers shall meet all the above criteria.**





## HIGH RELIABILITY

The chillers are equipped with twin rotor screw compressors having advanced 5-6 patented profiles for optimum modulation of volumetric ratios at all operating conditions of the chiller, and have several other advantages.

The Chiller has separate radial and axial force bearings, enhancing the chiller's life.

**Unlike a mono screw compressor, there is no direct contact between the gate rotor and main rotor, which eliminates wearing out of rotors.**

Advanced control algorithm prevents excessive compressor cycling.

It has automatic compressor unloading in case of abnormally high condensing pressure or discharge temperature and abnormally low suction pressure.

Simulation tools are employed for the design of critical components including mounting joints, lifting lugs etc.

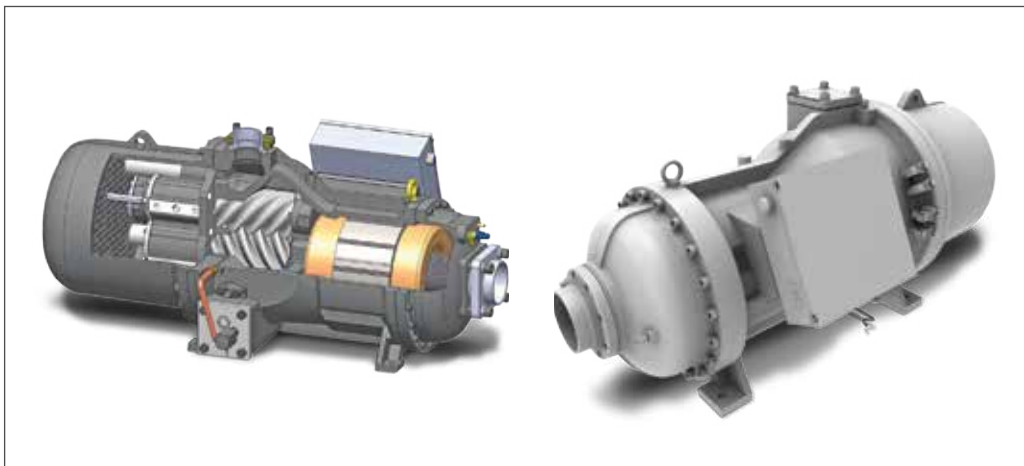

## SIMPLE AND FAST INSTALLATION

The new Blue Star configured series screw chiller is compact and suited for easy and quick installation. The innovative construction design has the following advantages:

- Simple electrical connections including easily accessible main disconnect switch
- Victaulic connection aiding in faster and better pipe connections compared to welded flanged joints
- Reversal of chilled water inlet and outlet connections to match site conditions
- Systematic factory operation test before shipment
- Easy accessibility of all compressor components on site, minimising downtime
- Discharge line shut-off valve and liquid line service valve for easy maintenance
- Practical reference marks for entering and leaving water connections

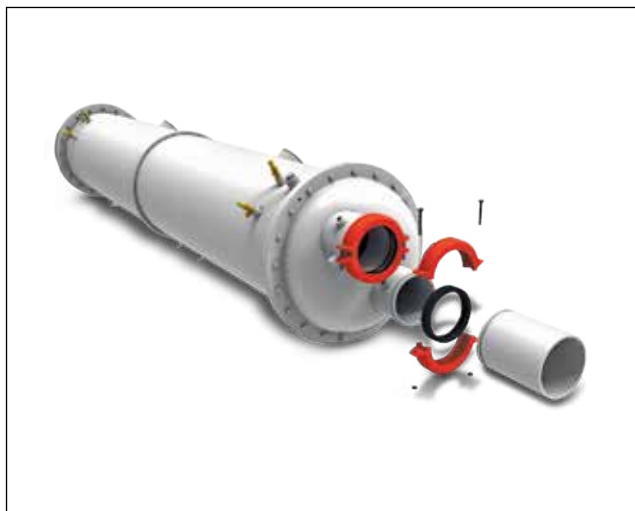

**Victaulic connections**

## AHRI CERTIFICATION FOR CHILLERS

The new Blue Star configured series screw chiller is manufactured at the company's own state-of-the-art ISO 9001 factory. The chillers are certified by the international rating body - the Air Conditioning, Heating and Refrigeration Institute (AHRI). Blue Star has India's only precision testing facility certified by AHRI to test and rate air cooled chillers manufactured in the country.





## ENVIRONMENT-FRIENDLY

R134a is recognised as an environment-friendly refrigerant which causes no damage to the ozone layer. The new chiller series with R134a refrigerant is designed with a leak-tight refrigerant circuit, completely avoiding the capillary tubes and flare connections with R134a refrigerant.



## COMPACT AND LIGHT-WEIGHT

Critical parts, like compressors, coolers and condensers, of these new generation configured screw chillers are not only efficient but also compact. The chillers are as much as 15% smaller in size and 10% lesser in weight when compared with a conventional chiller. The compact design helps to free up valuable floor space.

Width of these chillers are as low as 2.23m and can be easily accommodated in standard trucks.

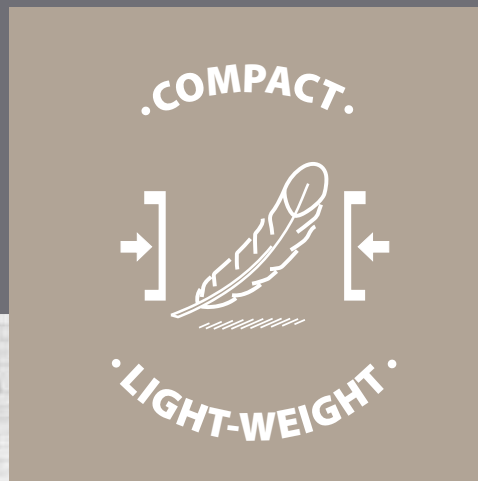





## LOWER NOISE & VIBRATION

- The new configured series screw chiller is equipped with 5-lobe, bird-wing design fans for optimised noise levels.
- Ultra low noise requirement can be catered through
  - ◆ VFD driven condenser fan
  - ◆ Acoustic enclosures for compressors
- Specially designed spring isolators provided with the chillers minimise vibration.



## LOW AMBIENT APPLICATION

Applications with high internal loads like data centres need the chillers to function even during winter conditions.

Condenser fans of the configured series screw chiller are available with the option of VFD. This will enable to operate the chiller at ambient temperature as low as 0°C.

### Operating Range

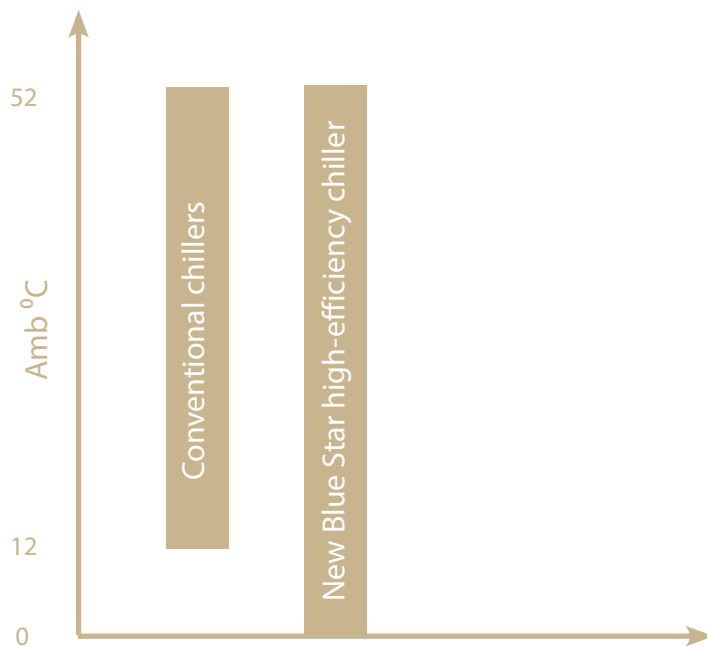

## ANTI-CORROSIVE TREATMENT

Applications involving highly corrosive environments can be provided with anti-corrosive hydrophobic coated fins, enhancing the corrosion resistance to more than 5 times the conventional fins.

For more severe applications Blygold metallic impregnated polyurethane coating can be provided for coils and fins, protecting the base metal from a wide range of corrosive salts and acids in the atmosphere.

Blygold coating not only protects the chillers from stringent corrosive environments but also ensures uniform efficiency with negligible impact on heat transfer and pressure drop.

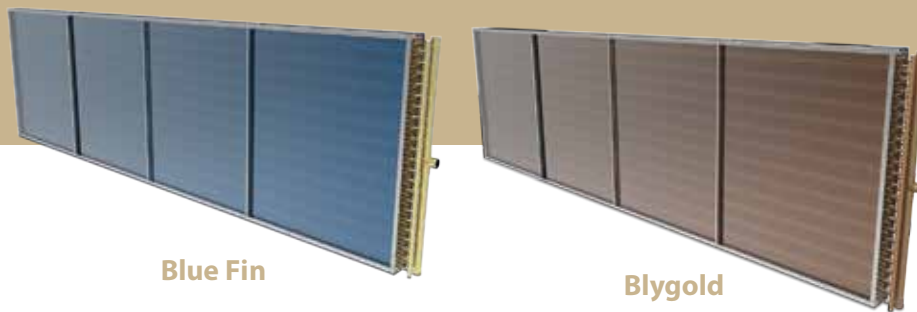

## ASME STAMPING





Blue Star's new generation configured series screw chiller is available with U Stamp for the pressure vessels in compliance with ASME (American Society of Mechanical Engineers), a renowned third party certifying organisation for safety of pressure vessels.



## REMOTE MONITORING SYSTEM



The chillers can operate through an advanced GPRS-based Remote Monitoring System available as an option to all users.

This system has the following advantages:

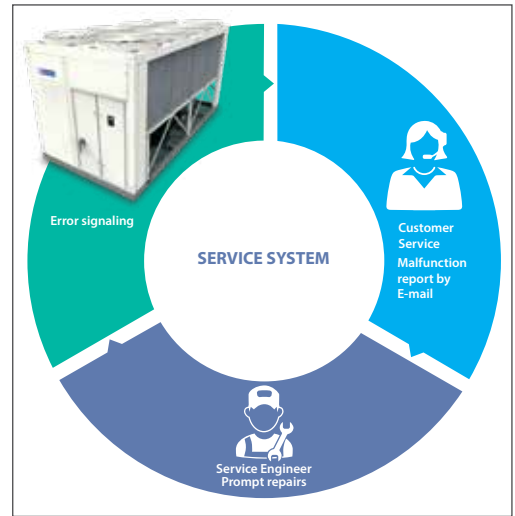
-  Close monitoring of the site irrespective of the location
-  24x7 automatic monitoring
-  Automatic notification in the form of SMS or e-mail in case of any error
-  Automatic call login for service



The data captured and sent by RMS to the Central Service Team enables analysis by the local service team to be equipped with the necessary solutions to resolve any issue speedily. This ensures:

-  Response time will be very quick
-  Turnaround time will be faster
-  Lesser downtime of the system

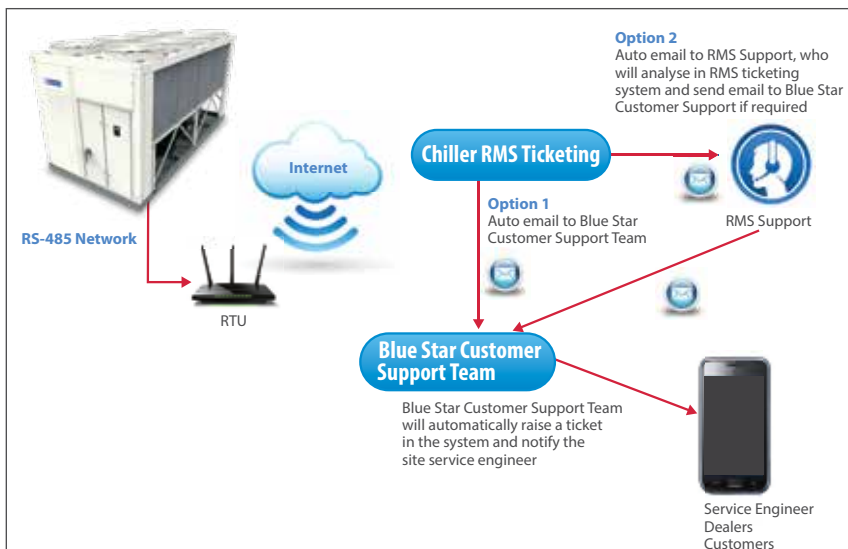



## ADVANCED FEATURES OF CONTROLLERS



Precise temperature control of +/- 0.5oC



Overload protection



Anti-freeze and no-flow protection



Overcurrent protection



Compressor run-time balancing



HP / LP protection



Automatic backup mode



Compressor run hours



Single phasing / phase loss protection



Password protection



**BMS**

BMS compatibility



Self-diagnosis control system



User-friendly machine interface



Stored past history and alarm



Alarm output



Display unit flexibility



Efficient operating zone algorithm



Demand restriction



Efficient oil separator



DLT protection



Oil level protection



# Widest Range of Products



VRF V Plus - 100% VRF System



VRF IV S - Side Discharge VRF System



VRF Sprint - Pre-piped VRF System



Inverter Ducted Splits & Packaged ACs



Packaged ACs & Ducted Splits



Water Cooled Centrifugal Chillers



Turbocor Chillers



Water Cooled Screw Chillers with VFD



Water Cooled Screw Chillers Configured Series.



Air Cooled and Water Cooled Scroll Chillers



Air Cooled & Water Cooled Condensing Units



Process Chillers



Scan QR Code - Blue Star Customer Care Mobile App



SMS "SERVICE" to 57575



Download Blue Star Customer Care Mobile App from App Store & Google Play



To know more about Blue Star, visit [www.bluestarindia.com](http://www.bluestarindia.com), email us at [coolingsolutions@bluestarindia.com](mailto:coolingsolutions@bluestarindia.com) or SMS 'COOL' to 57575



24X7 CUSTOMER CARE (Toll Free) 1800 209 1177 1860 266 6666

For more information, please contact **BLUE STAR LIMITED** **Ahmedabad:** 301 & 302, (3rd Floor), Abhishree Avenue, (Near) Nehru Circle, SM Road, Ambawadi, Ahmedabad - 380 015. Tel: (079) 40224000 **Bengaluru:** Anjuman KAY A R R Tower No - 28, Ward No 77, Mission Road, Bengaluru - 560027. Tel: (080) 41854000 **Bhubaneshwar:** 3A, Satya Nagar, 2nd Floor, Bhubaneshwar - 751 007. Tel: (0674) 2572403 / 2573670 **Chandigarh:** Adarsh Mall, 4th Floor, Plot No. 50, Industrial & Business Park, Phase - II, Chandigarh - 160 002. Tel: (0172) 5024000 **Chennai:** KRM Plaza, No 2, Harrington Road, Chetpet, Chennai - 600 031. Tel: (91) (44) 42444000 **Ghaziabad:** C 53A, Third Floor, Rajnagar District Center (RDC), Raj Nagar, Ghaziabad - 201001, Uttar Pradesh. Tel No: (0120) 2821400 **Goa:** 210, 2nd Floor, Gera's Imperium I, Patta, Panjim, Goa - 403 001. Tel: (0832) 2438171/2437287 **Gurgaon:** Vatika Atrium, 6th Floor, Golf Course Road, Sector 53, Gurugram - 122 002 (Haryana) Tel: (0124) 409 4000 **Guwahati:** Oasis Plaza, Dr. B. Baroah Road, Ulubari, Kamrup, Guwahati - 781007. Tel: (0361) 2468496 **Indore:** No. 502, Maloo-01, 26/C, Scheme No. 94/C Ring Road, Indore - 452 010 Tel: (0731) 4001211 / 4001311 **Jaipur:** A-19, 1st Floor, Main Sahakar Path, Near Sahakar Bhavan, Jaipur - 302 001. Tel (0141) 2744033-35 **Kochi:** 2nd Floor, Millennium Plaza, MKK Nair Road, Alinchuvadu Junction, Kochi - 682 024. Tel: (0484) 4499000 **Kolkata:** 7, Hare Street, Kolkata - 700 001. Tel: (033) 22134100 **Ludhiana:** SCO 16-17, Feroze Gandhi Market, Fortune Chambers, 3rd Floor, Ludhiana - 141001 (Punjab), Tel: 0161 5001404 **Lucknow:** 177/4, Faizabad Road, Lucknow - 226 007. Tel: (0522) 4034000 **Mumbai:** Blue Star House, 9-A, Ghatkopar Link Road, Saki Naka, Mumbai - 400 072. Tel: (022) 66684100 **Nagpur:** 219, Bajaj Nagar, 1st Floor, South Ambazari Road, Nagpur - 440 010. Tel: (0712) 2249000 / 6624000 **Pune:** 201/A, Nityanand Complex, 1st Floor, 247/A, Bund Garden Road, Pune - 411 001. Tel: (020) 41044000 / 26169332 **Raipur:** Alaska Corporates, 3rd Floor, Opp. VIP Road, Jivan Vihar Colony, G E Road, Raipur, Chhattisgarh - 492 006. Tel: (0771) 6544000 **Secunderabad:** Ashoka Raghupati Chambers, No 1-10-60 to 64, (4th Floor), S P Road, Begumpet, Hyderabad-500016 Telangana. Tel: (4044) 004000 **Thiruvananthapuram:** TC IV/962, 'Chandrika', Sree Chitra Nagar, PipeLine Road, Kawdiar, Thiruvananthapuram - 695 003. Tel: (0471) 2720025 / 65 **Vadodara:** Ramakrishna Chambers, 7th Floor, Productivity Road, Alkapuri, Vadodara - 390 007. Tel: (0265) 2330334 / 6614100 **Visakhapatnam:** D. No. 49-24-65/1, Near Sankarmatam Road, Madhura Nagar, Visakhapatnam -530 016. Tel: (0891) 2748405 / 2748433 **Vijaywada:** No. 40-1-62, Nagas Hafeez Plaza, Opposite to Grand Modern Super Market, Near BENZ Circle, MG Road, Vijaywada - 10 Tel: 0866 2484004